

100MM VENTILATION ACCESSORIES



TERMINATION SET

Used as a decorative inlet grille or soffit termination set in conjunction with 100mm or 125mm diameter ducting. Two fixing screws supplied to secure grille to the spigot through material up to 25mm thick.

Dimension 155mm x155mm.

Colour: White.

Material: ABS plastic.

Stock Ref. No. 56 35 13

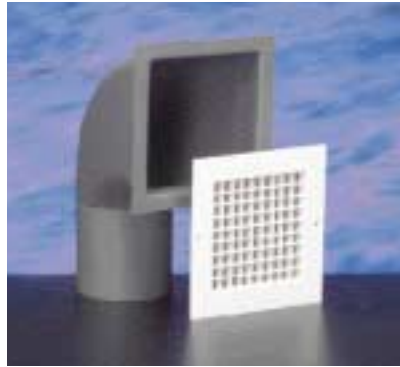

TERMINAL CONNECTOR AND GRILLE

Used for the termination of 100mm flexible ducting to the ceiling or wall of small areas, such as internal toilets.

Connector: manufactured in flame-retardant high impact thermoplastic.

Colour: Grey.

Grille: ABS plastic eggcrate, white finish.

See also Multi-spigot plates (page 128) and flexible ducting (page 129)



AIR GRILLE

Louvred grille for external termination of 100mm diameter rigid ducting. Consists of wall mounting piece and grille with 2 fixing screws.

Colour: White or Brown.

Dimensions: 155 x 155 x 32mm.

Material: ABS plastic.

White Stock Ref. No. 56 35 11

Brown Stock Ref. No. 56 35 00

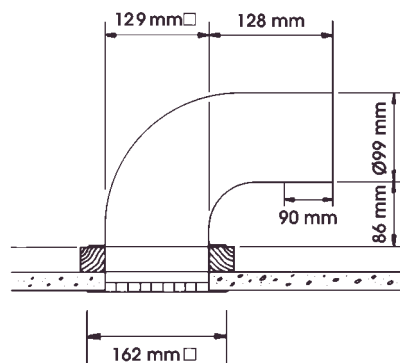

Vent-Axia terminal connector and grille Part	Stock Ref. No.
Connector only	56 08 56
Grille only	56 08 46



QUICK FIT 100MM GRILLE

Wall outlet grille complete with 100mm spigot and two quick fix grips for fast installation to rigid ductwork without further fixings.

Dimensions: 155 x 155 x 20mm.

Material plastic

White Stock Ref. No. 56 35 21

Brown Stock Ref. No. 56 35 41



QUICK FIX TERMINATION

The quick fix termination is designed to be installed from inside the building to a nominal 115mm diameter core-cut hole, saving time and cost. Four sealing rings afford a weather tight fit to the wall external leaf. Effective length 370mm.

Stock Ref. No. 56 35 35A



WIND BAFFLES

A new range of 100mm and 150mm weather baffles. Cowled wall outlet with damper protected gravity grille.

Available in white and brown they are ideal for exposed, high rise or coastal applications, helping to prevent unwanted backdraughts.

100mm White Stock Ref. No. 45 20 94

150mm White Stock Ref. No. 45 20 96

100mm Brown Stock Ref. No. 45 20 95

150mm Brown Stock Ref. No. 45 20 97



QUICK FIT 100MM AIRFLOW SHUTTER

Shutter with gravity flaps to protect against backdraught. The spigot connects to 100mm rigid ducting using quick fix grips provided.

Dimensions: 155 x 155 x 20mm.

Material plastic

White Stock Ref. No. 56 35 22

Brown Stock Ref. No. 56 35 42

100MM VENTILATION ACCESSORIES



CONDENSATION TRAP

100mm Condensation trap, for fitting in vertical rigid PVCu pipe ducting. Must be used where pipe ducts pass through unheated roof voids. Fitted with 20mm pipe connection for running off condensate. Not suitable for use with flexible ducting.

For installation details [see page 5](#).

Length 85mm
Material: Grey PVCu.

100mm **Stock Ref. No. 56 35 16**
125mm **Stock Ref. No. 45 51 91**
150mm **Stock Ref. No. 45 51 90**



VENT COWL

External termination for 100mm diameter rigid ducting through roofs and walls in exposed situations. Overall diameter 200mm. Not suitable for use with flexible ducting.

Material: Grey PVCu.

Stock Ref. No. 56 14 03

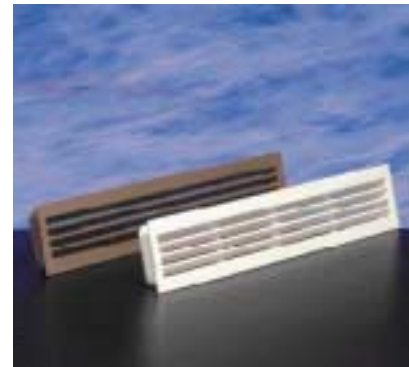

AIR REPLACEMENT SET

Bathroom and toilet ventilation is only effective when there is adequate air replacement into the room. This is often most effectively achieved by fitting a pair of air replacement grilles at low level in a door. Consists of a two piece telescopic set which fits unobtrusively on either side of the door panel.

Minimum fixing thickness: 30mm.
Dimensions: 454 x 90mm.
Hole size: 435 x 76mm.
Material: High impact thermoplastic.
115cm² free area.

Ivory: **Stock Ref. No. 56 14 01**
Brown: **Stock Ref. No. 56 14 00**



100MM DIAMETER SINGLE AIRBRICK ADAPTOR

Used to connect single airbrick to 100mm diameter circular duct.

Stock Ref. No. 46 66 81

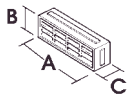

A-214mm
B- 62mm
C- 57mm

System 25 Airbrick

Free area 4645mm²

- Blue/Black Stock Ref. No. 46 66 35
- Rustic Red Stock Ref. No. 46 66 37
- Terracotta Stock Ref. No. 46 66 36
- Rustic Brown Stock Ref. No. 46 66 39
- Buff Sand Stock Ref. No. 46 66 38

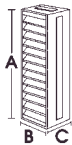

A-216mm
B- 65mm
C- 57mm

System 25 Soldier Course Air Brick

Designed for upright use.

Free area 6210mm²

- Terracotta Stock Ref No. 46 87 28
- Buff Sand Stock Ref No. 46 87 29
- Rustic Brown Stock Ref. No. 46 87 30



DOUBLE AIRBRICK TO CIRCULAR DUCT ADAPTOR

Used to connect double air brick to 100, 125 or 150mm diameter round ducting.

Stock Ref. No. 46 91 23

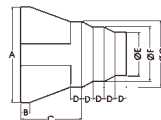

A- 217x140mm
B- 20mm
C- 137mm
D- 25mm
E- Ø99mm
F- Ø124mm
G- Ø149mm

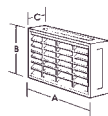

A-215mm
B-138mm
C- 58mm

System 50 Airbrick

Free area 12580mm²

- Blue Black Stock Ref. No. 46 68 07
- Terracotta Stock Ref. No. 46 68 08
- Rustic Red Stock Ref. No. 46 68 09
- Buff Sand Stock Ref. No. 46 68 10
- Rustic Brown Stock Ref. No. 46 68 11