

## Cable Tray Systems

# 06

**01**

Standard &  
Lighting Trunking

**02**

Floor  
Trunking

**03**

Skirting  
Trunking

**04**

Dado & Bench  
Trunking

**05**

Special  
Trunking

**06**

Cable Tray  
Systems

**07**

Cable  
Supports

**08**

Speedway  
Ladders

# 06

**THE UNITRUNK RANGE** of Cable Tray Systems has been developed to suit the demands of an ever changing market. Considerable investment in state of the art computerised machinery has developed a production facility which is able to respond quickly to the demands of the market, making Unitrunk one of the most advanced companies in this field.

**Customer satisfaction** is of paramount importance to Unitrunk and great care is taken to ensure that the highest standards of manufacture are maintained.

Unitrunk Cable Tray Systems consist of light, medium and heavy duty pattern with standard perforations.

**Finish:** The requirements of a cable tray finish can range, depending upon the situation, from being purely cosmetic to being capable of providing protection in the most corrosive environments. Unitrunk Cable Tray is produced in pre-galvanised mild steel to BS EN 10142 as standard but is available in a wide range of materials and finishes.

**Available finishes include:**  
Pre-galvanised to BS EN 10142  
(standard references throughout brochure)

Post galvanised to ISO EN 1461  
(prefix reference with GA)

Epoxy powder coated  
(prefix reference with EPC)

Plastic coated  
(prefix reference with PC)

## Light Duty Cable Tray

Part No. LD/T 50 - 225

All light duty tray lengths up to and including LD225T will be supplied with an inwards form on one end to ease installation. LD300/T and above will still require the use of couplers.

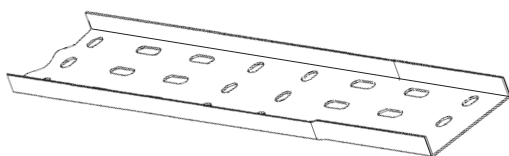

**FLANGE HEIGHT**

13.5mm on 50-225mm width



21.5mm on 300-900mm width



**PATTERN DETAIL**

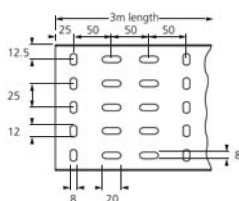

Part no.	Gauge mm	Tray Width mm	Weight kg
LD50T	0.9	50	1.46
LD75T	0.9	75	1.88
LD100T	0.9	100	2.44
LD150T	0.9	150	3.40
LD225T	1.2	225	6.24
LD300T	1.2	300	8.82
LD450T	1.5	450	15.46
LD600T	1.5	600	20.56
LD750T	1.5	750	24.52
LD900T	1.5	900	29.52

## Straight Coupler

Part No. LD/SC  
Length 161mm

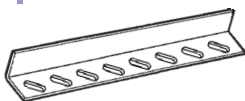

## Cranked Coupler

Part No. LD/CC (pair)

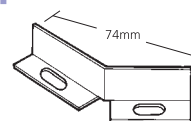

## Fish Plate

Part No. LD/FP 225-900mm  
Tray width less 58mm/Gauge 1.5mm

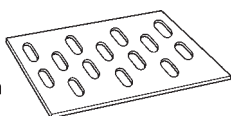

## Reducer

Part No. LD/R  
Total length 250mm

Please state sizes required

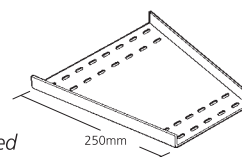

## Earth Link

Copper  
Tin coated copper

## Bolts & Nuts

M6X12 Order separately



## Medium Duty Cable Tray

Part No. MR/T 50 - 900

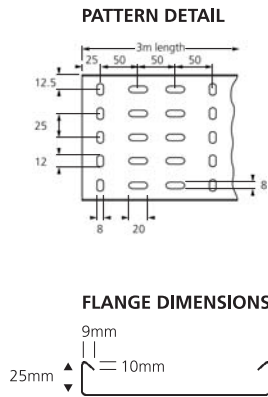
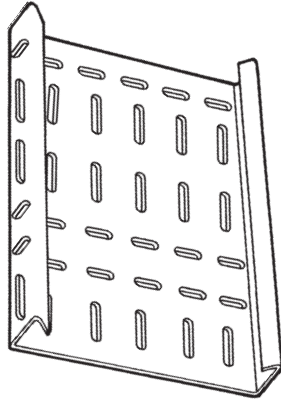

Part no.	Guage mm	Tray Width mm	Weight kg
MR50T	0.9	50	2.24
MR75T	0.9	75	2.74
MR100T	0.9	100	3.24
MR150T	0.9	150	4.06
MR225T	0.9	225	5.58
MR300T	1.0	300	8.50
MR450T	1.5	450	16.70
MR600T	1.5	600	21.33
MR750T	1.5	750	26.20
MR900T	1.5	900	31.60

## Straight Coupler

Part No. MR/SC  
Length 225mm

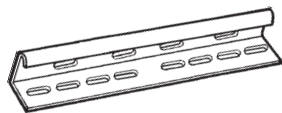

## Cranked Coupler

Part No. MR/CC (pair)

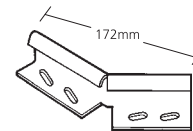

## Fish Plate

Part No. MR/FP 225-900mm  
Tray width less 58mm/Gauge 1.5mm

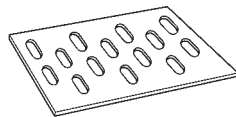

## Reducer

Part No. MR/R  
Total length 250mm

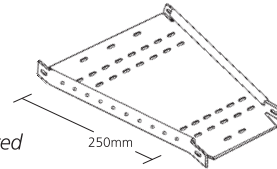

Please state sizes required

## Covers & Brackets

VENTILATED 6 brackets required per cover  
NON-VENTILATED complete with Turnbuckle type fixing

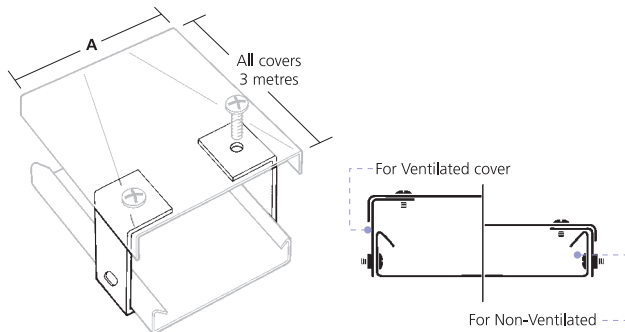

Size mm	A mm	Guage mm	Weight kg
50	83	0.9	1.76
75	105	0.9	2.23
100	130	0.9	2.76
150	180	0.9	3.82
225	255	0.9	5.41
300	330	1.2	9.33
450	481	1.5	16.99
600	631	1.5	22.29
750	782	1.5	27.62
900	932	1.5	32.92

## Conduit Take-off Plate

Part No. TR/TOP 20mm  
Part No. TR/TOP 25mm  
Suitable For Light/Medium/Heavy

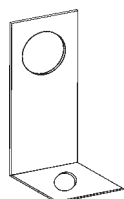

## Earth Link

Copper  
Tin coated copper

## Bolts & Nuts

M6X12 Order separately



## Heavy Duty Cable Tray

Part No. HR/T 75 - 900

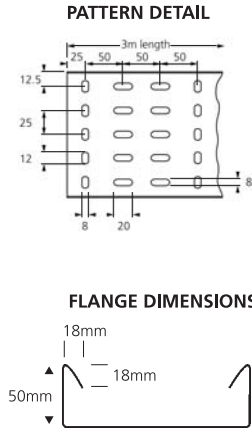
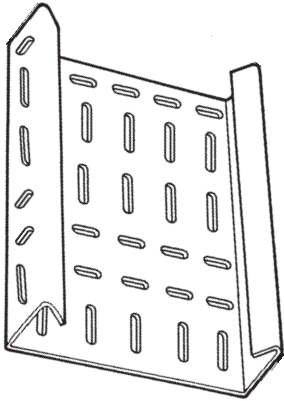

Part no.	Gauge mm	Tray Width mm	Weight kg
HR75T	0.9	75	4.10
HR100T	0.9	100	5.22
HR150T	0.9	150	5.86
HR225T	1.2	225	9.22
HR300T	1.2	300	11.56
HR450T	1.5	450	19.78
HR600T	1.5	600	23.93
HR750T	2.0	750	37.50
HR900T	2.0	900	45.25

All GA Trays as above except:

GAHR600T	2.0	600	31.10
----------	-----	-----	-------

## Straight Coupler

Part No. HR/SC  
Length 225mm

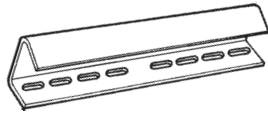

## Cranked Coupler

Part No. HR/CC (pair)

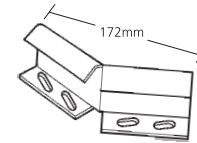

## Fish Plate

Part No. HR/FP 225-900mm  
Tray width less 58mm/Gauge 1.5mm

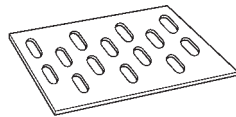

## Reducer

Part No. HR/R  
Total length 250mm

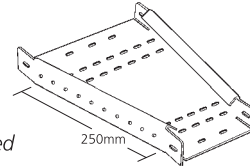

Please state sizes required

## Covers & Brackets

VENTILATED 6 brackets required per cover  
NON-VENTILATED complete with Turnbuckle type fixing

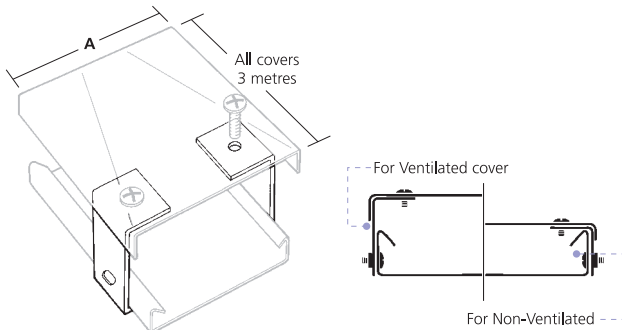

Size mm	A mm	Gauge mm	Weight kg
75	105	0.9	2.23
100	130	0.9	2.76
150	180	0.9	3.82
225	255	0.9	5.41
300	330	1.2	9.33
450	481	1.5	16.99
600	631	1.5	22.29
750	782	1.5	27.62
900	932	1.5	32.92

## Tray Overhead Hangers

Part No. OH3-12  
Suitable for Light/Medium/Heavy  
2mm Pre or Post Galvanised Steel  
Size range 75mm-300mm

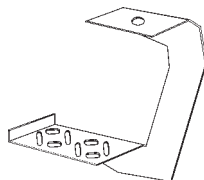

## Earth Link

Copper  
Tin coated copper

## Bolts & Nuts

M6X12 Order separately



## Light Duty Cable Tray

Load Deflection

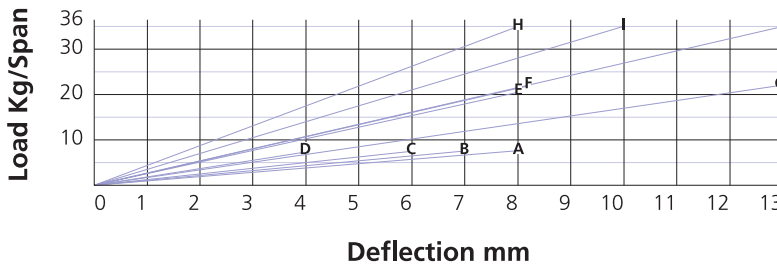

### SPAN

- A 1.5m x 50mm
- B 1.5m x 75mm
- C 1.5m x 100mm
- D 1.5m x 150mm
- E 1.5m x 225mm
- F 1.5m x 300mm
- G 1.5m x 450mm
- H 1.5m x 600mm
- I 1.5m x 750mm
- J 1.5m x 900mm

## Medium Return Tray

Load Deflection

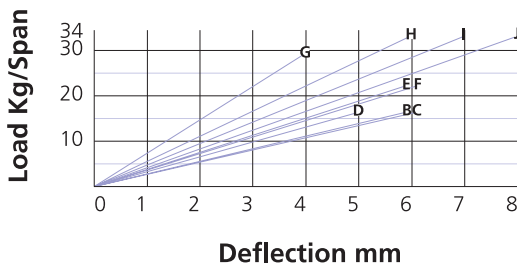

### SPAN

- B 2.0m x 75mm
- C 2.0m x 100mm
- D 2.0m x 150mm
- E 2.0m x 225mm
- F 2.0m x 300mm
- G 2.0m x 450mm
- H 2.0m x 600mm
- I 2.0m x 750mm
- J 2.0m x 900mm

## Heavy Return Tray

Load Deflection

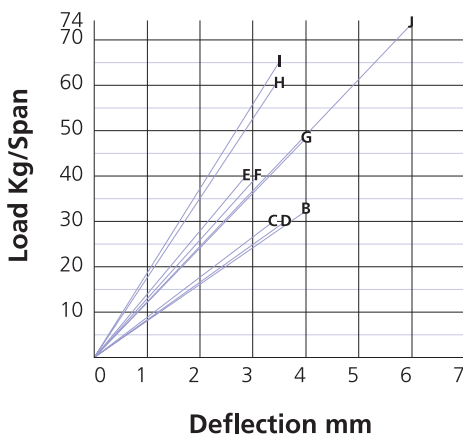

### SPAN

- B 2.0m x 75mm
- C 2.0m x 100mm
- D 2.0m x 150mm
- E 2.0m x 225mm
- F 2.0m x 300mm
- G 2.0m x 450mm
- H 3.0m x 600mm
- I 3.0m x 750mm
- J 3.0m x 900mm

#### HEAD OFFICE

**Unitrunk**  
Blaris Industrial Estate  
Altona Road, Lisburn  
Co Antrim BT27 5QB  
  
Telephone 028 9262 5100  
Facsimile 028 9262 5101  
Email Lisburn@unitrunk.co.uk

**Unitrunk (Manchester)**  
Unit 2 Orbital Way  
Windmill Lane  
Denton M34 3QA  
  
Telephone 0161 336 1177  
Facsimile 0161 336 1188  
Email Manchester@unitrunk.co.uk

**Unitrunk (Wolverhampton)**  
Titan 2, Coxwell Avenue  
Wolverhampton Science Park  
Stafford Rd, Wolverhampton WV10 9RT  
  
Telephone 01902 717786  
Facsimile 01902 714105  
Email Wolverhampton@unitrunk.co.uk

**Unitrunk (Harlow)**  
Unit G, Flex Meadow  
Merring Way, Harlow  
Essex CM19 5TJ  
  
Telephone 01279 444481  
Facsimile 01279 444405  
Email Harlow@unitrunk.co.uk

**Unitrunk (Scotland)**  
Caputhall Road  
Deans Ind. Estate, Livingston  
West Lothian EH54 8AS  
  
Telephone 01506 461964  
Facsimile 01506 461969  
Email Livingston@unitrunk.co.uk

**Unitrunk (Ireland)**  
Unit 17 Rosemount Park Drive  
Rosemount Business Park  
Ballycoolin Road, Dublin 11  
  
Tel 00 353 (0) 1 8200292  
Fax 00 353 (0) 1 8223533  
Email Dublin@unitrunk.ie